

Coupe BB
 ech:1/25
 indice A

parking

terrasse

intérieur

fini parking -0.02

fini terrasse -0.02

éxistant -0.20

futur fini ± 0.00

+2.35

+5.17⁷

+5.15

+4.91⁵

+5.66⁵

+5.34

0

1

détail 2

détail 7

Lt - 2x78x325

UPN200

Lt - 185x281

console avec HEA180 à souder sur chantier

bardage acier(hors lot)

HEA200

détail 5

Pt - 140x226

détail 1

couverture bac acier(hors lot)
 liteaux 30x40mm(hors lot)

Feuillard métallique ép = 6mm
 3 plis Douglas ép = 19mm

Chevron - 78x259

IPE200

IPE200

IPE200

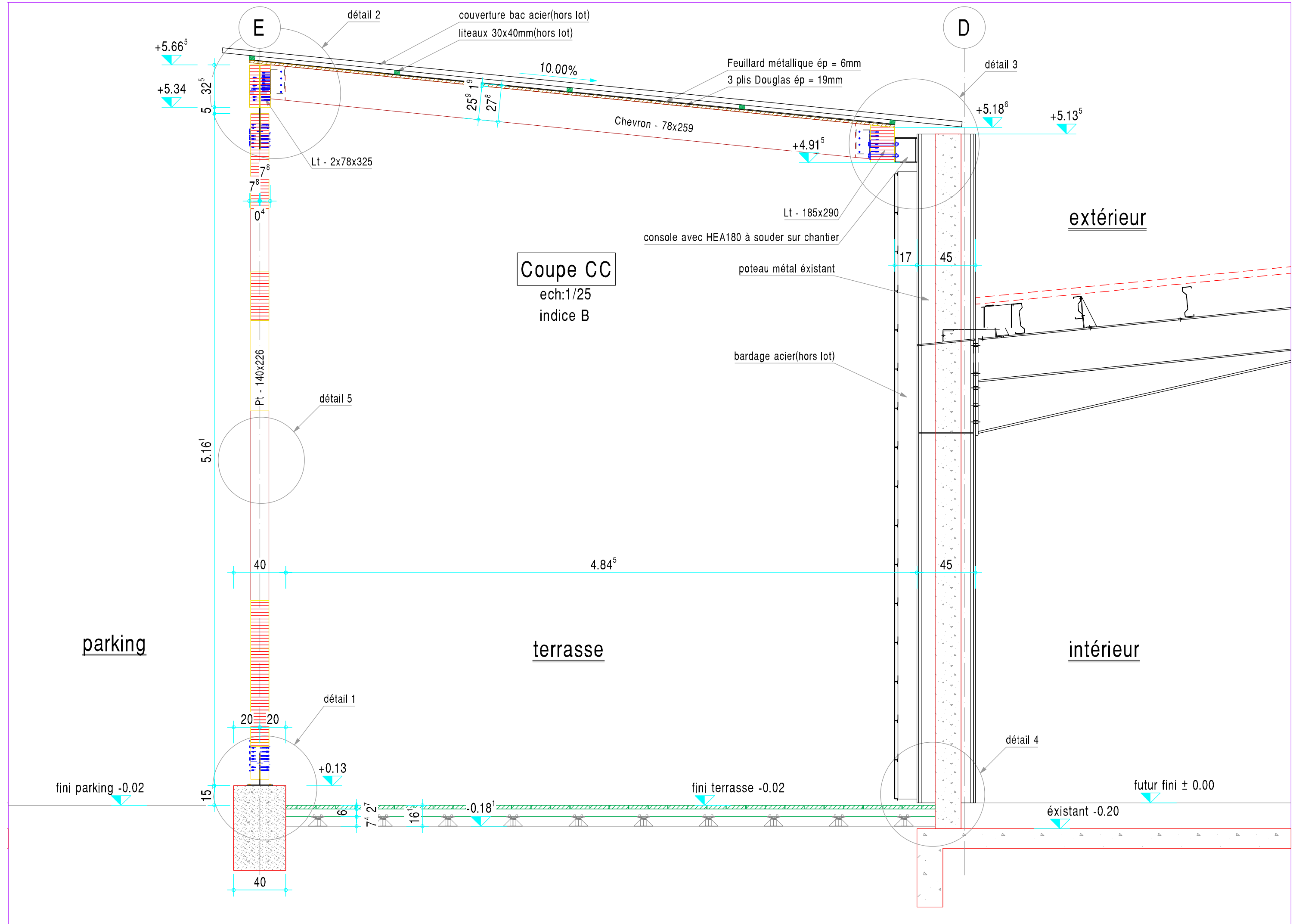

Détail 1

ech:1/5
indice B

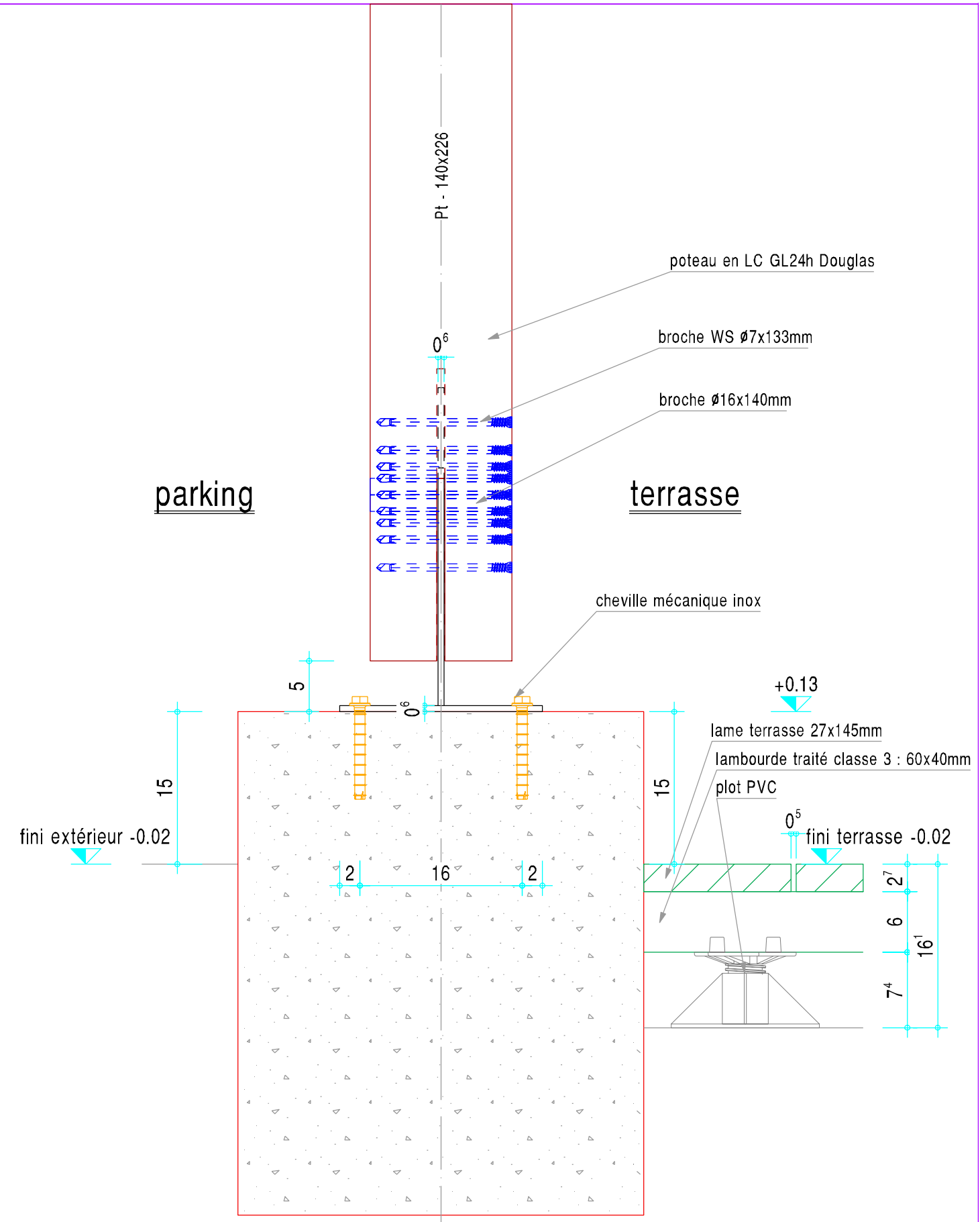
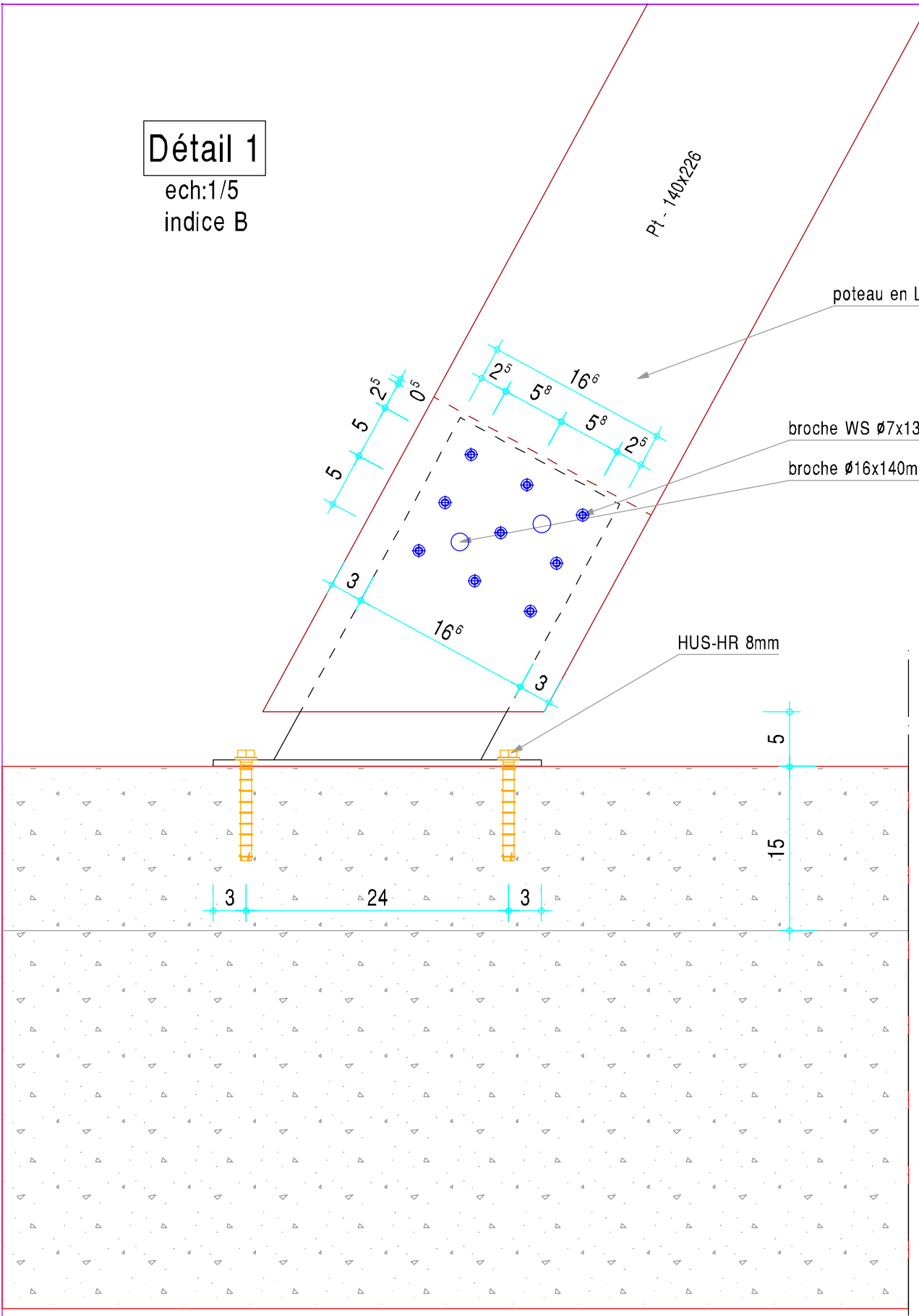

E

Détail 2

ech:1/5
indice B

E

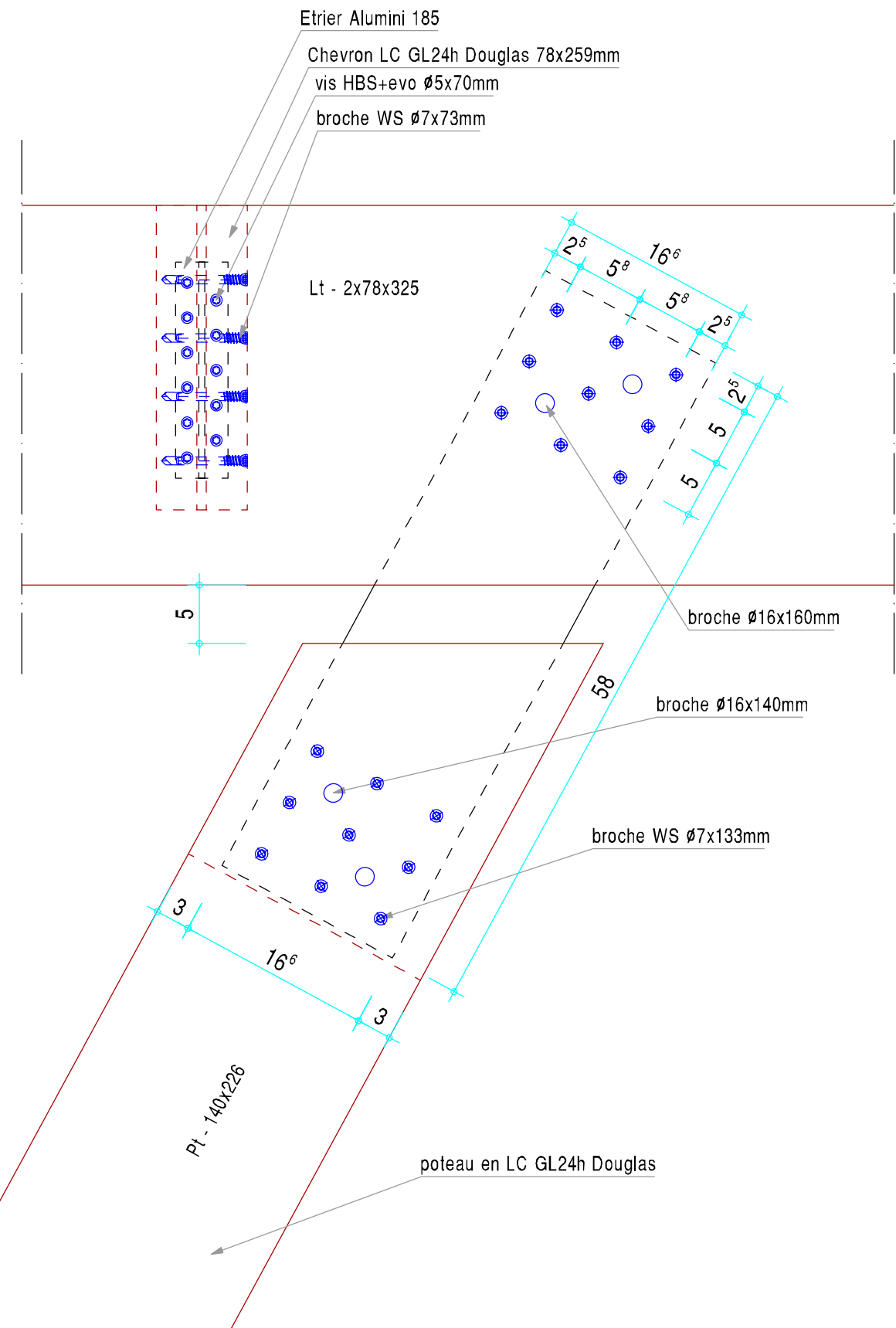
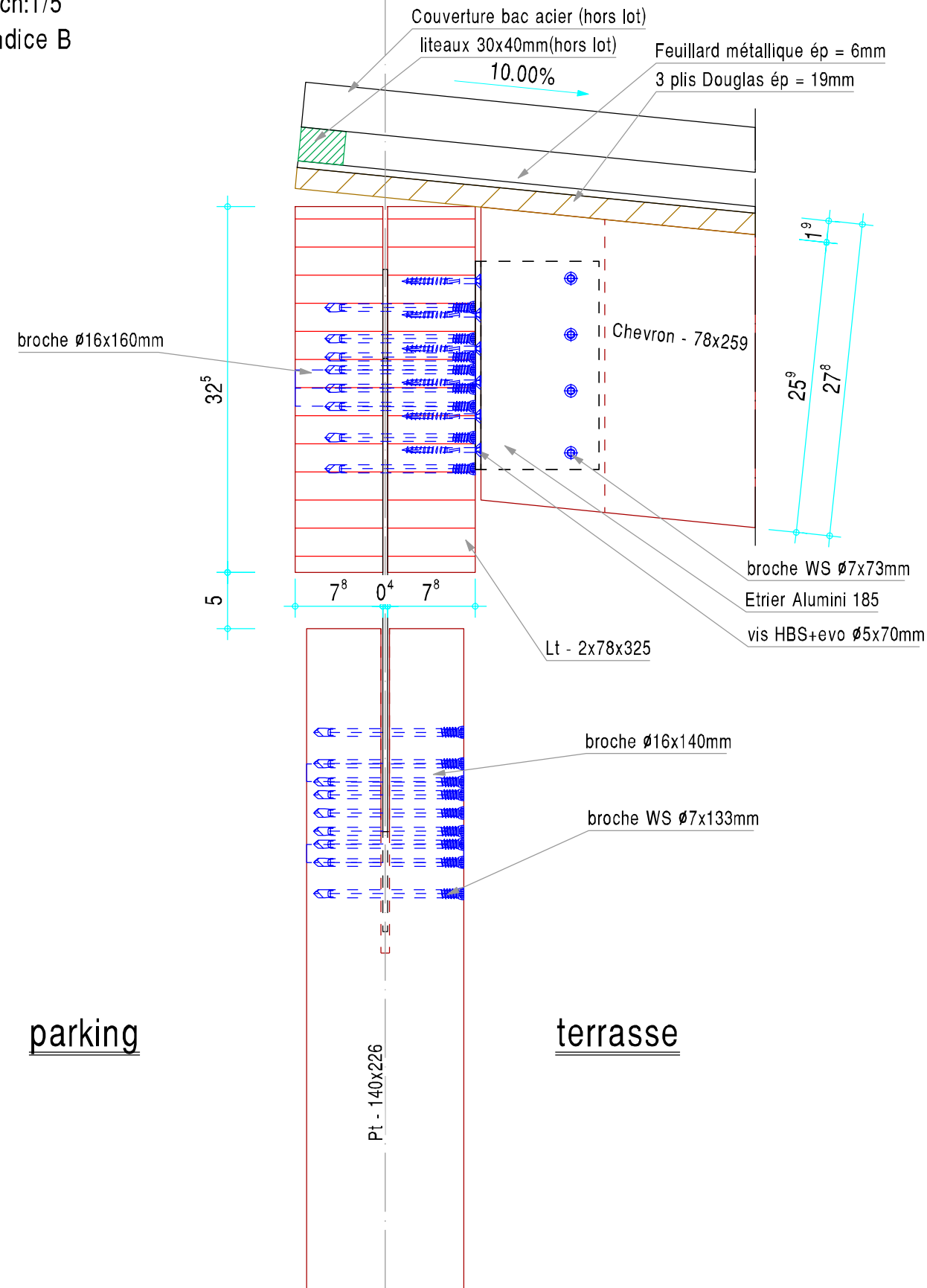

Détail 3

ech:1/5
indice B

vue de face

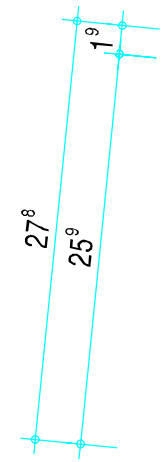

- Couverture bac acier (hors lot)
- 3 plis Douglas ép = 19mm
- Feuillard métallique ép = 6mm
- ligneul GL24h Douglas 185x290mm (hors lot)
- litesaux 30x40mm(hors lot)

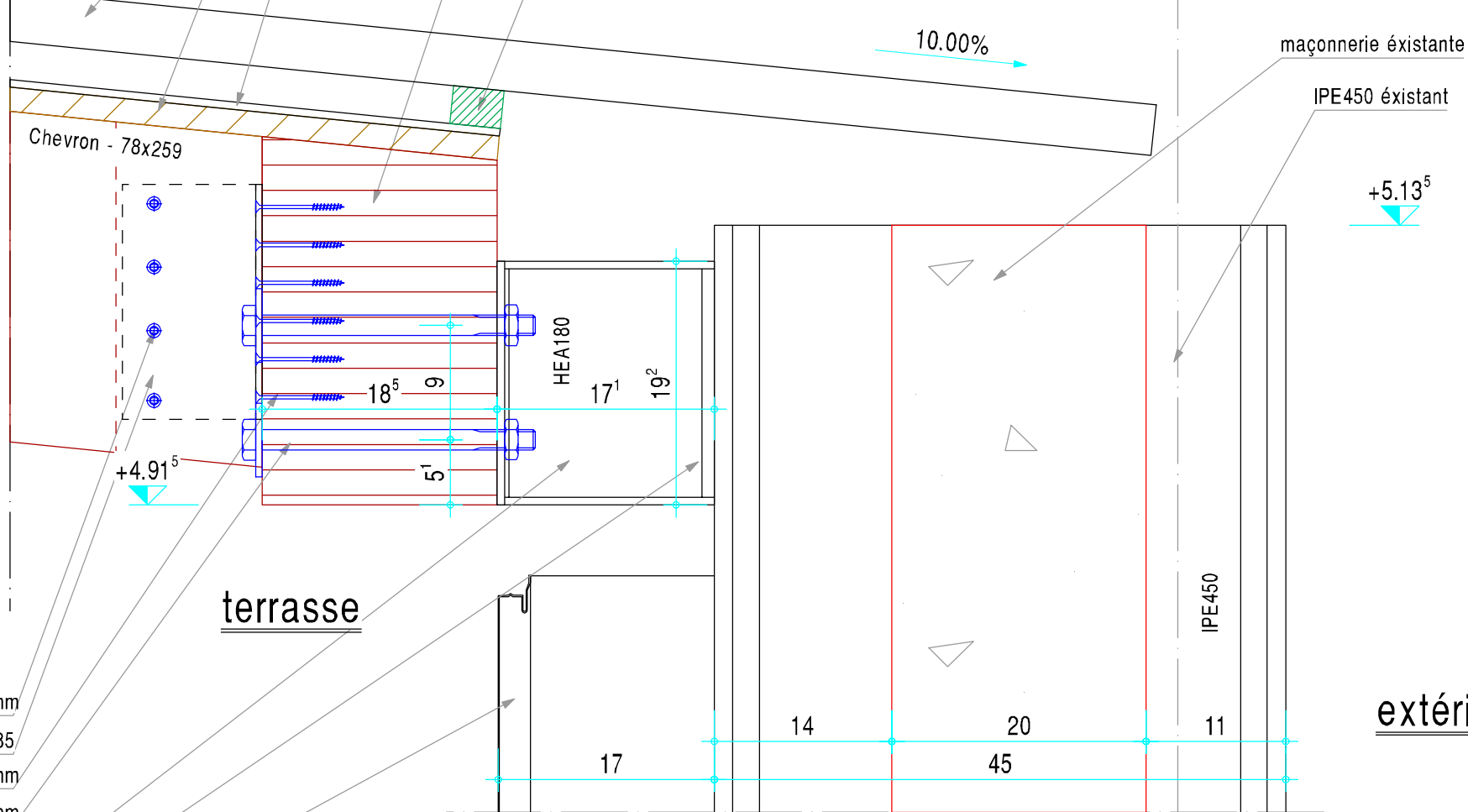

- broche WS $\varnothing 7 \times 73$ mm
- Etrier Alumini 185
- vis HBS+evo $\varnothing 5 \times 70$ mm
- boulon $\varnothing 16 \times 220$ mm
- console avec HEA 180 à souder sur chantier

- boulon $\varnothing 16 \times 50$ mm
- bardage acier(hors lot)

- ligneul GL24h Douglas 185x290mm (hors lot)
- boulon $\varnothing 16 \times 220$ mm
- console avec HEA 180 à souder sur chantier

vue de dessus

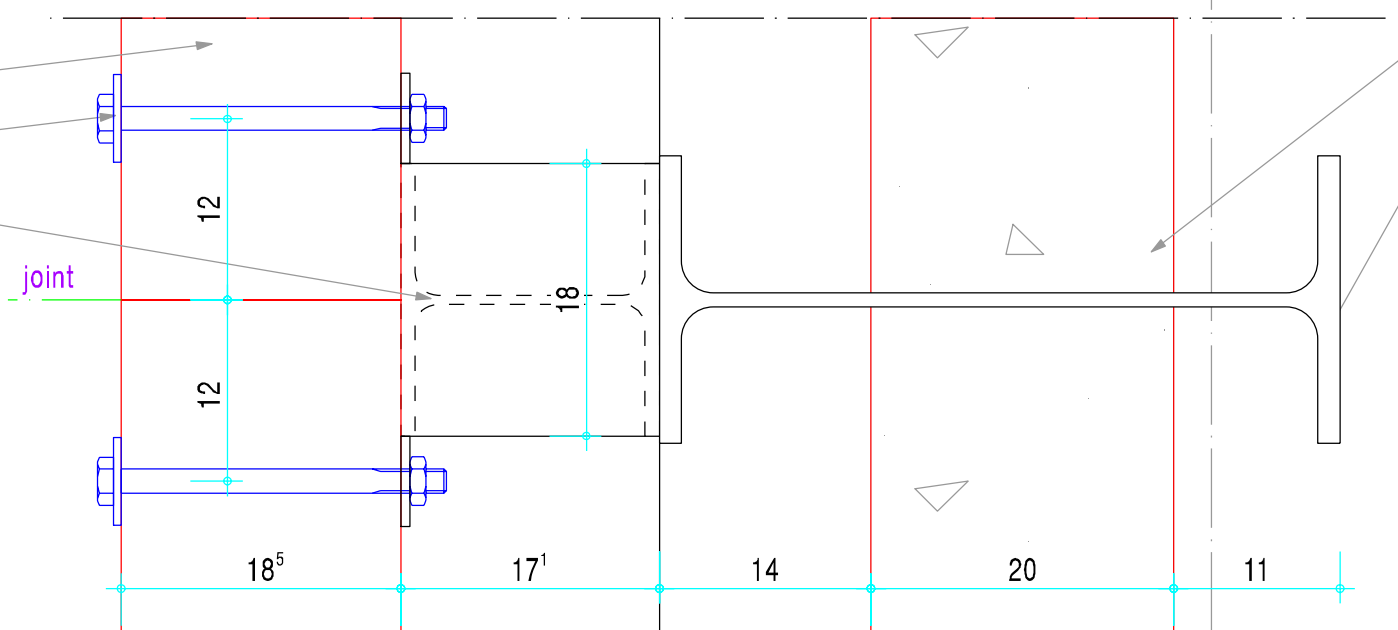

Détail 4

ech:1/5

indice A

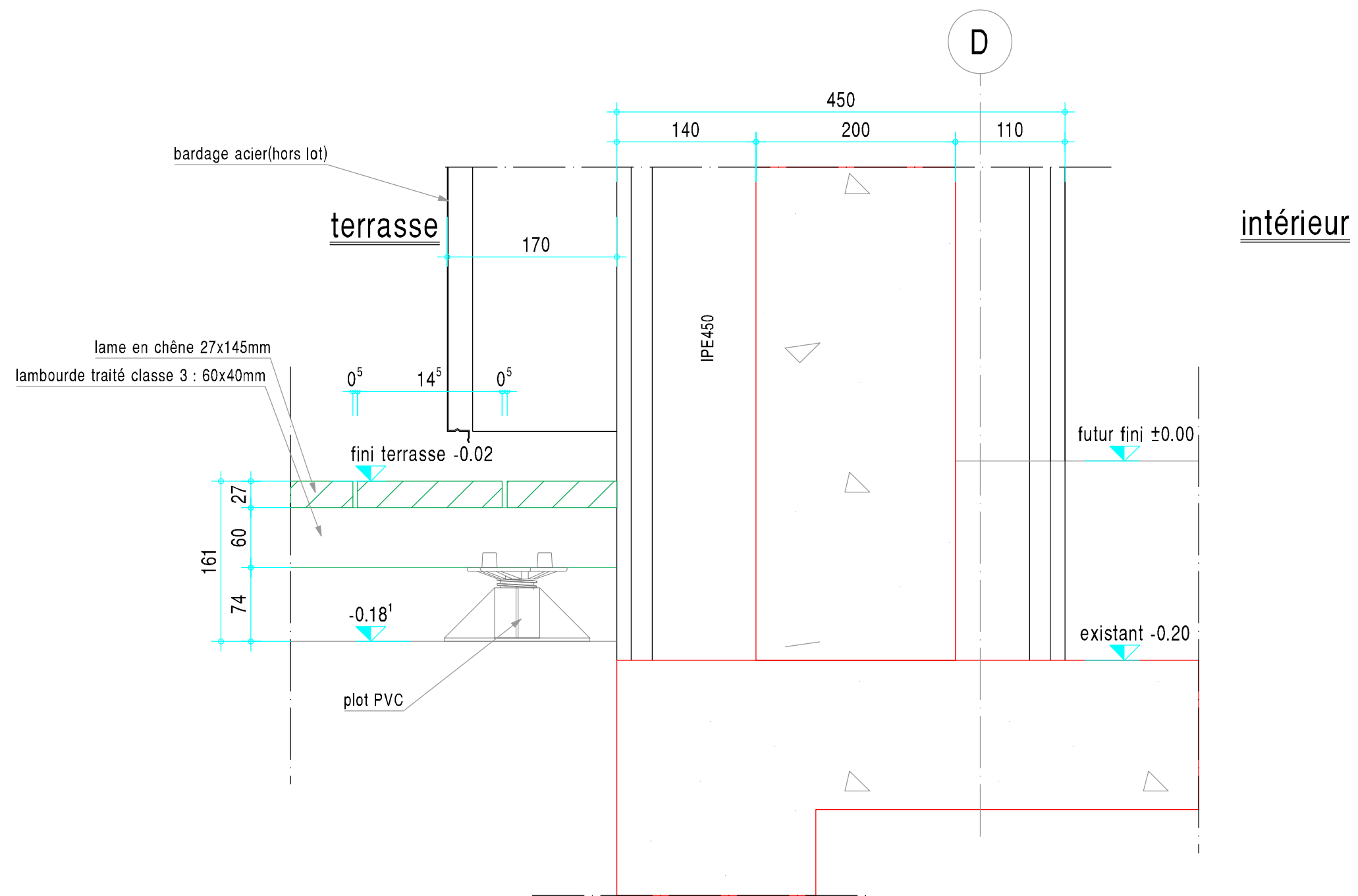

Détail 5

ech:1/5

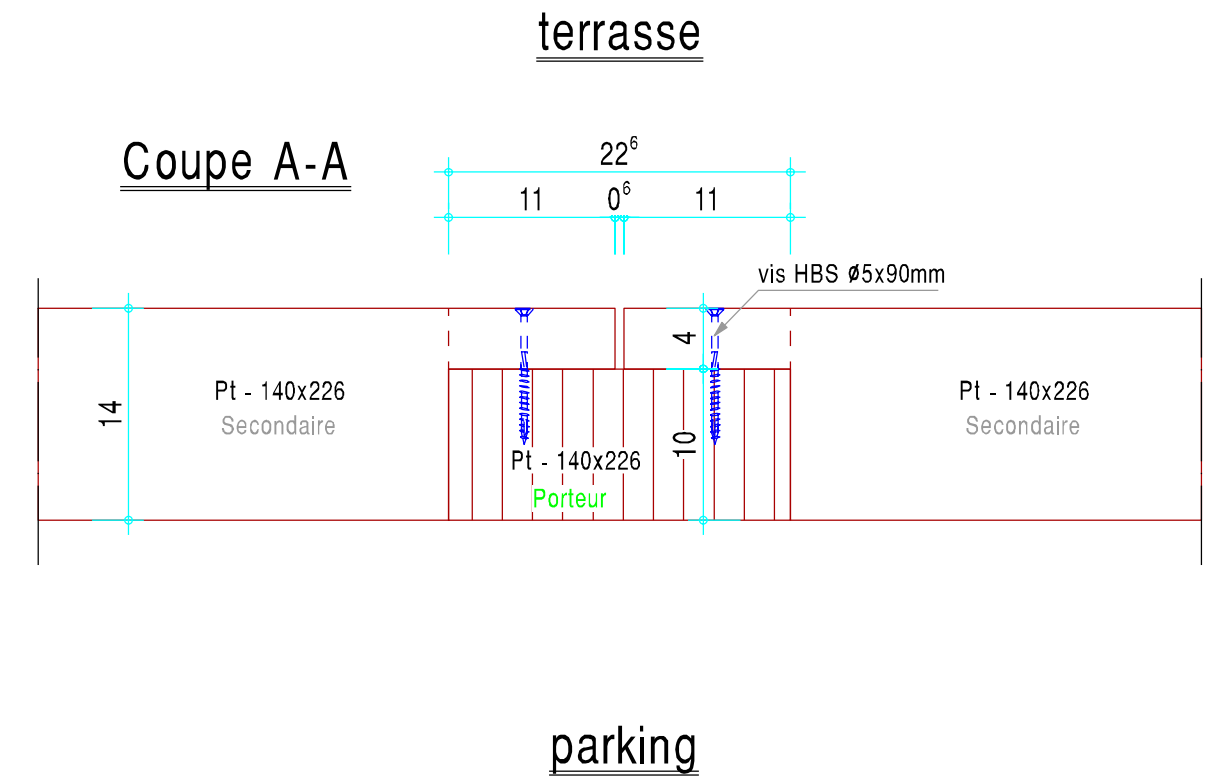
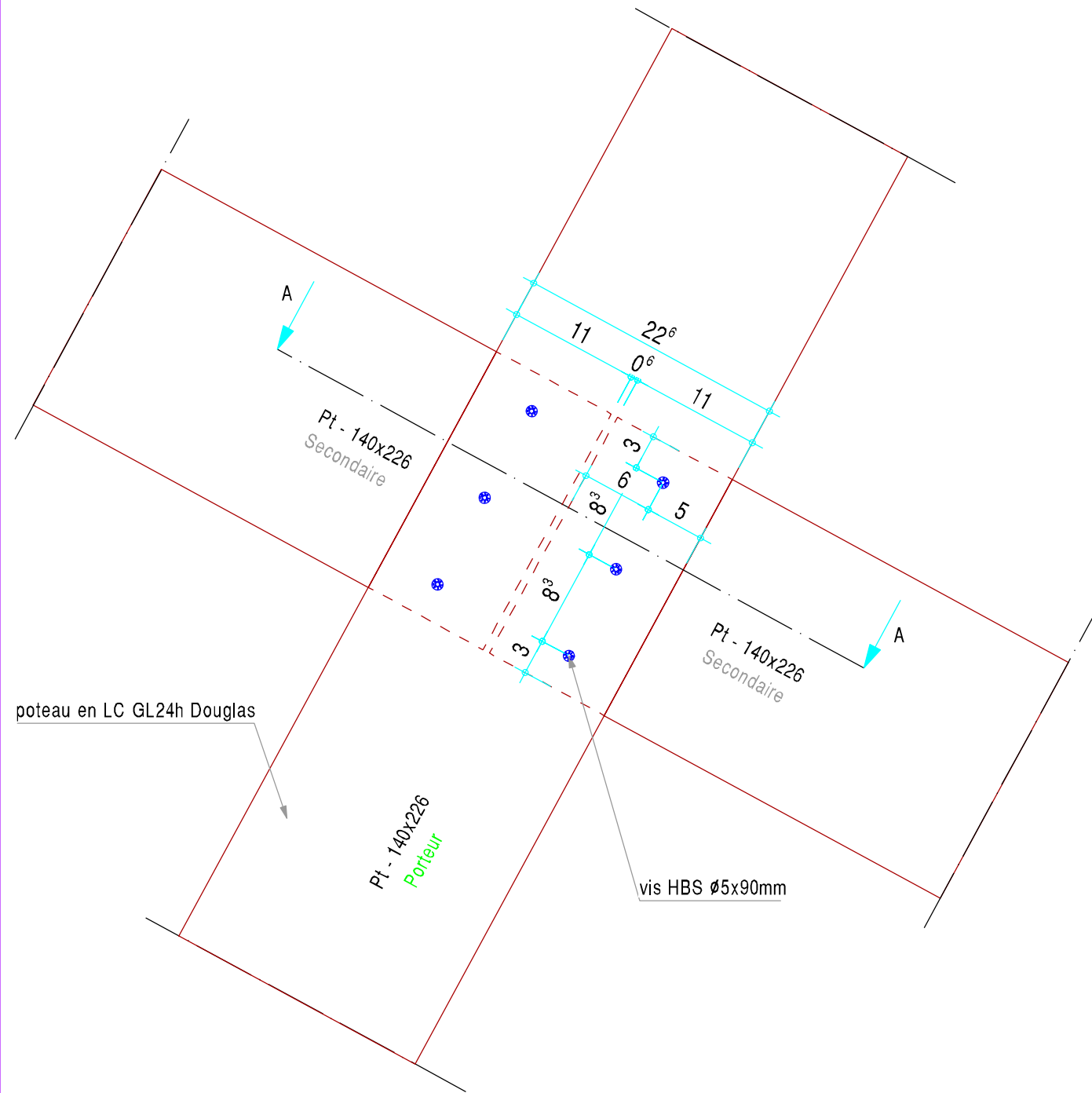

Détail 6
ech:1/5

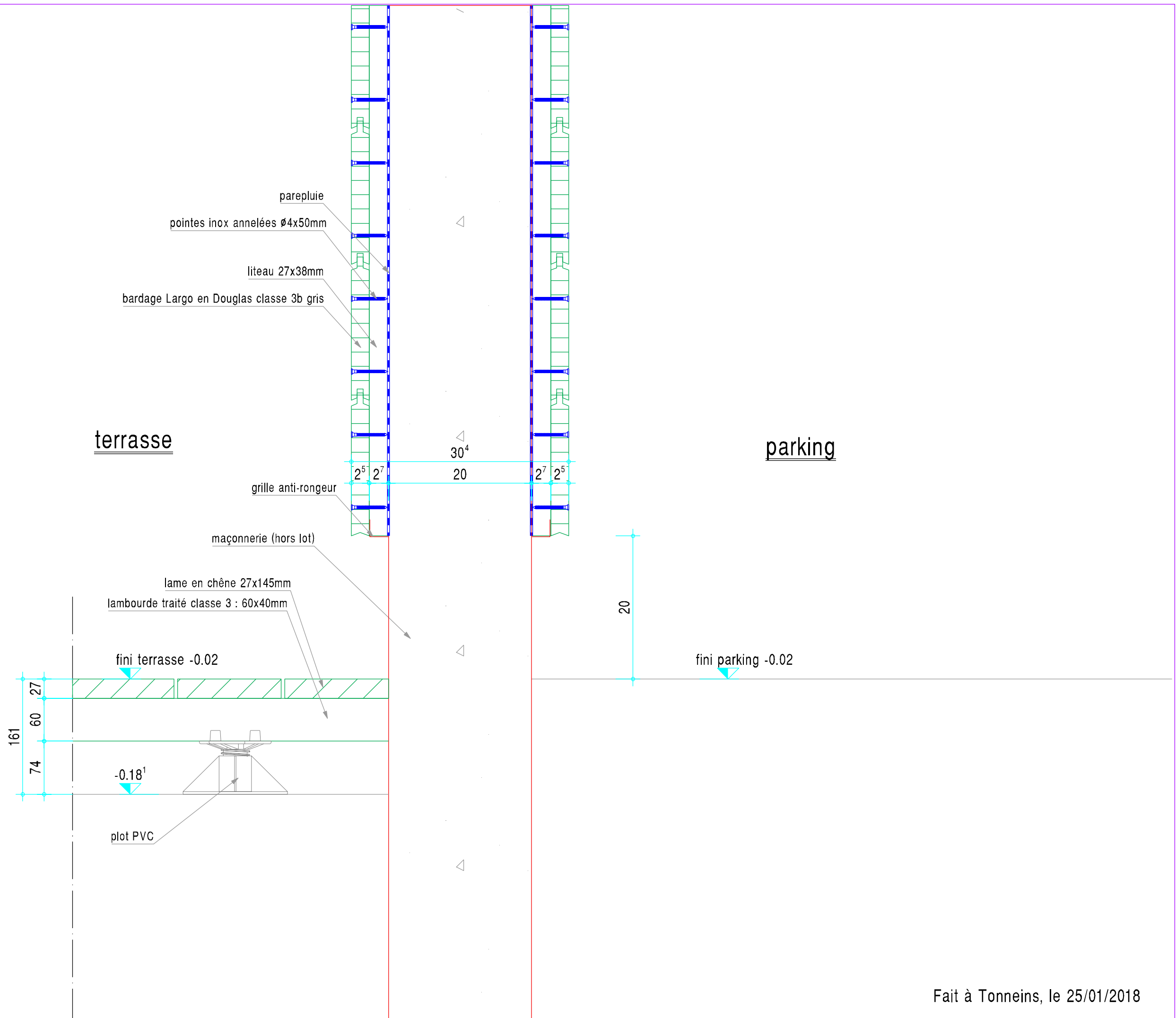

Détail 7

ech:1/5
indice A

vue de face

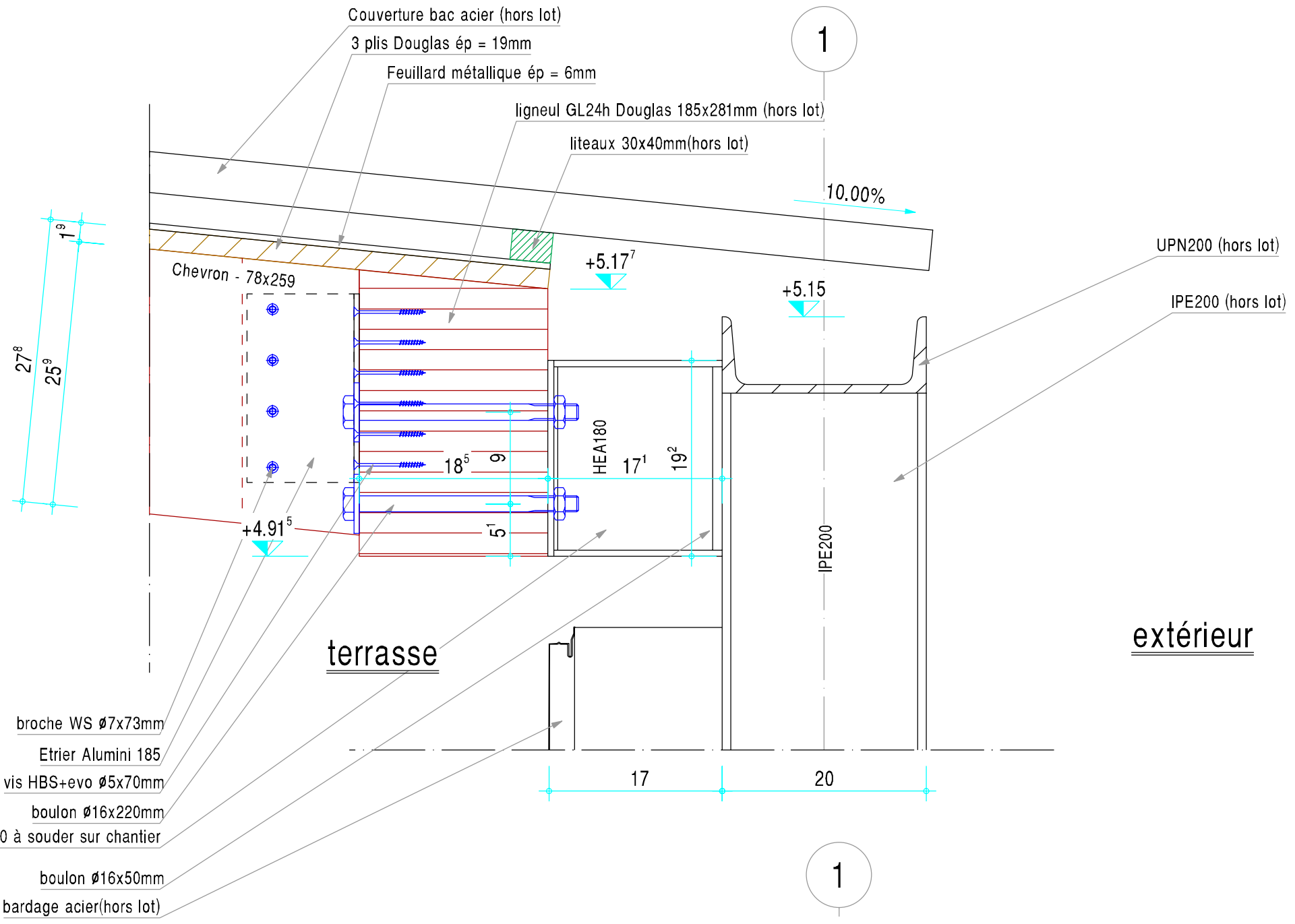

vue de dessus

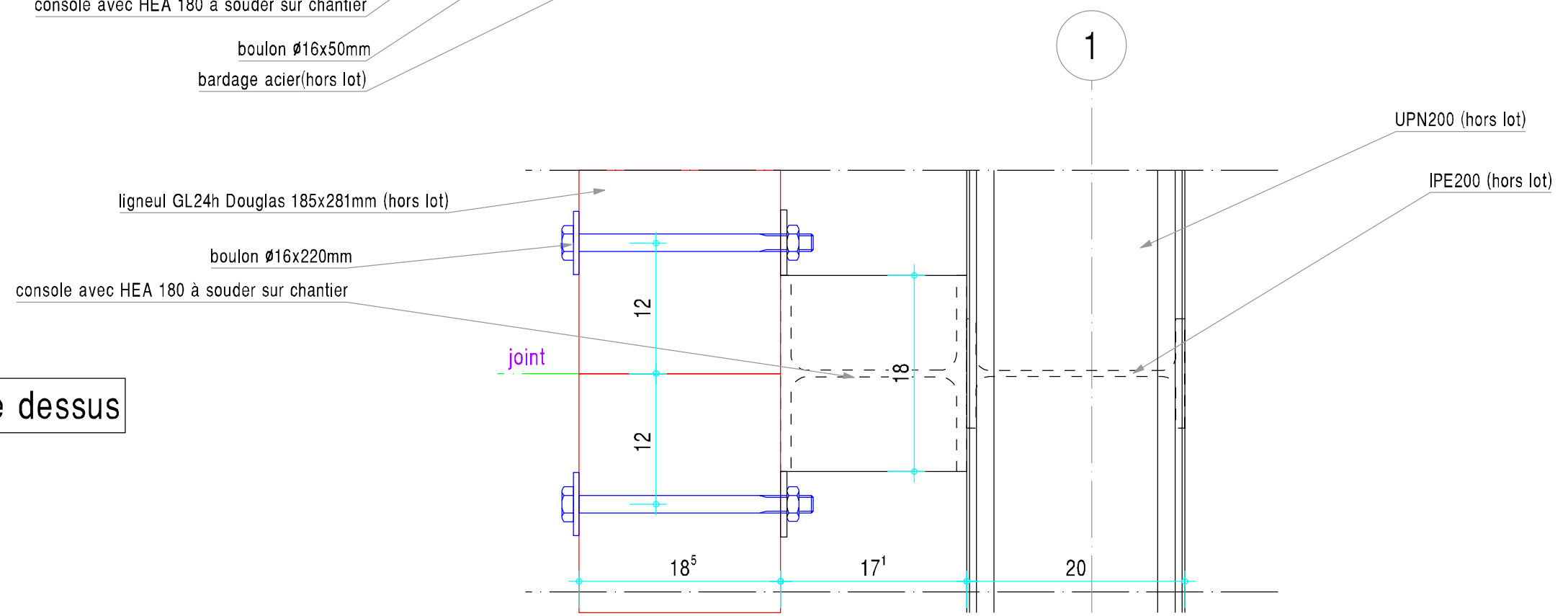

Détail 8

ech:1/5
indice A

vue de face

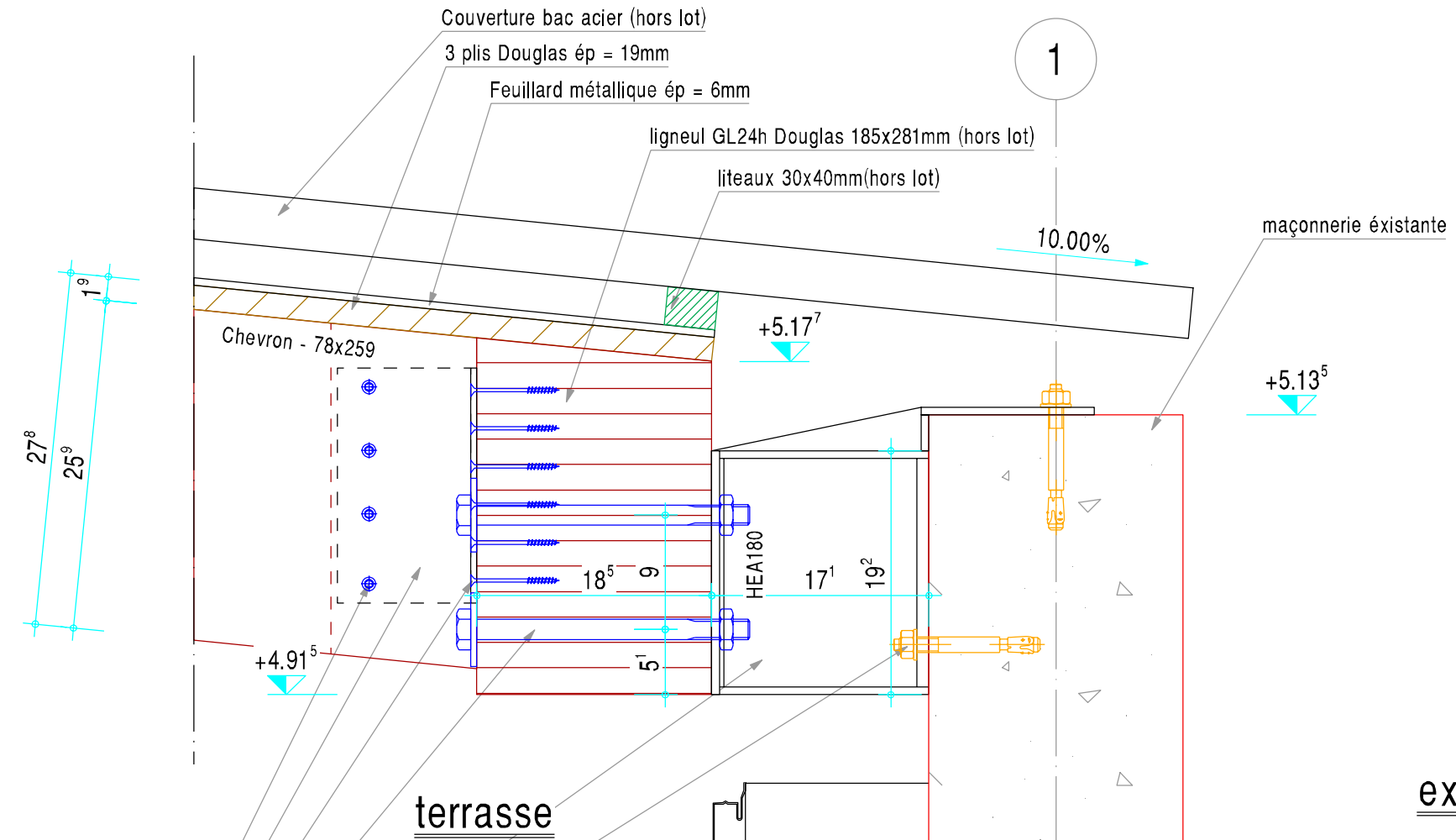

- broche WS Ø7x73mm
- Etrier Alumini 185
- vis HBS+evo Ø5x70mm
- boulon Ø16x220mm
- console avec HEA 180
- HST M12x115mm
- bardage acier(hors lot)

vue de dessus

